

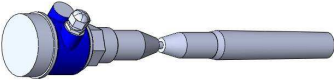

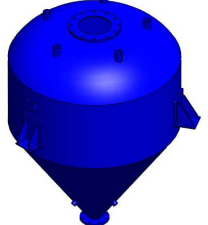

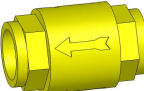

Ersatzteile Druckkesselanlage

Pos.Nr.	Art.-Nr.	Bezeichnung	Maße/Werte	Abbildung
1	200005	Vorsilo	1,2 m ³	
2	200002	Gitterrost	1000 mm	
3	200003	Außenrüttler	OR100	
4	200169	Füllstandsonde	FTC 260	
5	200007	Pneumatik Absperrklappe	DN250 Z 014 K1	
5-1	200120	Absperrklappe ohne Antrieb	DN 250	
5-2	200123	Antrieb	EB 10	
5-3	200403	Endschalterkasten		
5-4	200401	Gummimanschette	DN 250	
6	200040	Schlauchschelle	260 mm	
7	200078	Gummimanschette	260 mm	
8	200008	Zwischenflansch	250 x 40	
9	200013	Manometer	80 mm 4 bar	
10	200247 200240	Schalldämpfer	1" 1 1/4"	
11	200011	Entlüftungsventil	1"	

Handel & Service

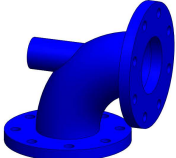
12	200012	Sicherheitsventil	S 245-1“	
13	200042	Füllstandsonde	FTC262	
14	200014 200020	Druckkessel	1150 L 1550 L	
15	200030	Rückschlagventil	¾“	
16	200015	Pneumatik Absperrklappe	DN 100 Z014K1	
16-1	200120	Absperrklappe ohne Antrieb	DN 100	
16-2	200015	Antrieb	EB 6	
16-3	200403	Endschalterkasten		
16-4	200402	Gummimanschette	DN 100	
17	200172 200168	Injektionsrohr	½“ ¾“	
18	200016	Rohrbogen	100	
19	200019 200017	Anschlußflansch	1 ½“ 2“	
20	200126 200128 200130 200132 200143 200136 200138 200140 200142	Reduzierstück	26mm 28mm 30mm 32mm 34mm 36mm 38mm 40mm 42mm	

Handel & Service

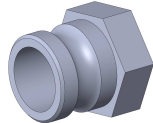
	200144 200146 200148 200150 200152		44mm 46mm 48mm 50mm 52mm	
21	200043	Festkupplung	VT-50-2“ VT-35-1 1/2“	

Armaturenschrank Druckkesselanlage

	200170	Wasserabscheider	1 1/2“	
	200023 200049	Magnetventil	1“ 1/2“	
	200024	Druckminderer	1“	
	200091	Druckschalter	Digital	
	200095	Druckerhöherpumpe 230 Volt	0,37 KW	
	200171	Manometer	0-10 bar	
	200050	Magnetventil	1/4“	
	200046	Magnetventil	1/4“	
	200173	Zylinder	100x400	

Schlauch und Spritzausrüstung

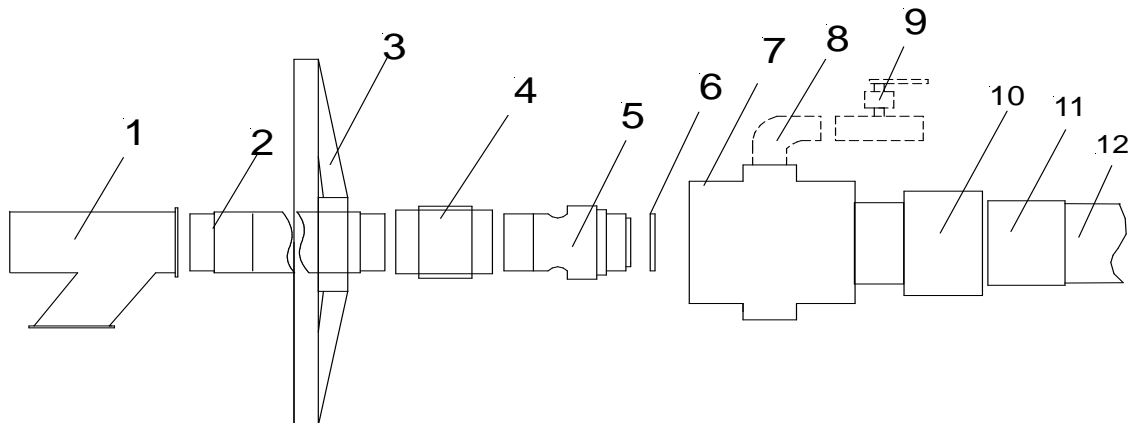

Pos.Nr.	Art.-Nr.	Bezeichnung	Maße/Werte
1	200102	Umlenkstück	1 1/2"
2	200103	Spritzrohr	3 m lang
3	200104	Schutzring für Düsenmischkörper	DN40
4	200045	Drehdurchführung	DN 40
5	200105	Heißreparaturstück mit Wasserring	DN 40
6	200106	Dichtung	DN 40
7	200107	Düsenmischkörper	DN 40
8	200108	Bogen	1/2"
9	200109	Nadelventil	3/8"
10	200110	Schlauchkupplung Vaterstück	DN40
11	200112	Schlauchkupplung Mutterteil	DN 40
12	100325	Förderschlauch	42x 9 mm