

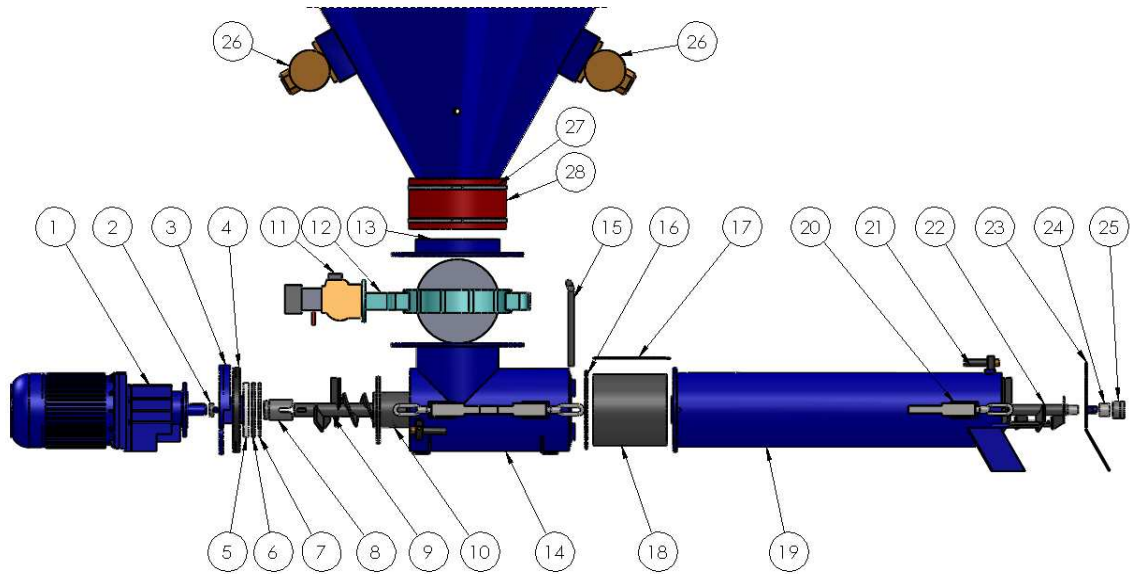

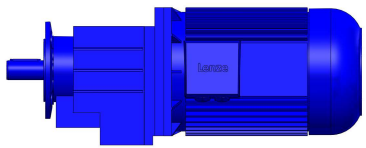







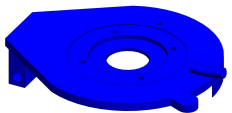

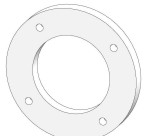
Ersatzteilliste

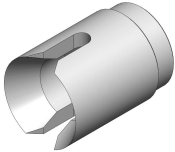
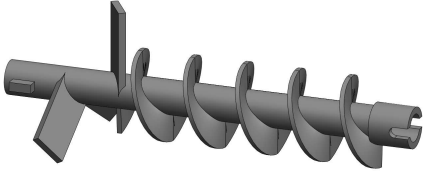
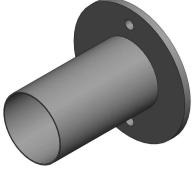

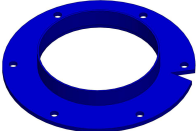

Mischrohr

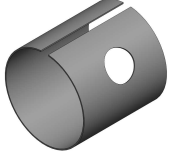

Pos.Nr.	Art.-Nr.	Bezeichnung	Maße/Werte	Abbildung
1	100115	Motor <i>electric gear motor</i>	5,5 kW 280 U/min	
2	100472	Distanzstück <i>distanze piece</i>		
3	100112	Motorflansch <i>electric gear motor flange</i>		
4	100122	Dichtungsprofil <i>sealing profile</i>		
5	100136	Kunststoff ring <i>plastic ring</i>		
6	100137	Gummischeibe <i>rubber disc</i>	160x46x8	
7	100138	Klemmring <i>clamp ring</i>		

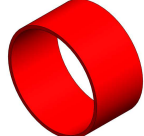
8	100116	Mitnehmerklaue <i>driver claw</i>		
9	100106 100108	Dosierwelle kurz <i>metering shaft short</i> Dosierwelle lang <i>metering shaft long</i>		
10	100120	Verschleißteil kurz <i>wearing part short</i>		
11	100139	5/2-Wege Ventil <i>5/2 way valve</i>	24 V	
12	100117	Absperrklappe <i>flap</i>	250 mm	
13	100140	Flansch mit Stutzen <i>flange</i>	DN 250	
14	100101	Einlaufrohr kurz <i>inlet pipe short</i>		
15	100114	Stecker <i>plug</i>		
16	100419	O-Ring <i>o-ring</i>	230	
17	100110	Stützleiste <i>supportgib</i>		
18	100109	Verschleißhülse <i>wearing bushing</i>		

19	100102 100103	Mischrohr <i>mixing chamber</i>	1000 mm 800 mm	
20	100123	Exzenterverschluß <i>eccentric shutter</i>		
21	100124	Näherungsschalter <i>approximation switch</i>		
22	100104 100105	Mischwelle <i>mixer shaft</i>	1000 mm 800 mm	
22	100126	Mischflügel <i>mixing paddel</i>		
22	100128	Innenring <i>inside ring</i>	20x25x30	
23	100111	Lagerdeckel <i>bearing cap</i>		
24	100127	Lager <i>bearing</i>		
25	100113	Lagerhalter komplett <i>bearing complete</i>		
25	100129	Lagerhalter <i>bearing holder</i>		
25	100182	Schmiernippel <i>lubricating nipple</i>	M 6	
26	100181	Außenrüttler <i>vibrator</i>	400 V	

27	100141	Schlauchschelle <i>clamp</i>	250-280	
28	100307	Gummimanschette <i>rubber collar</i>	260	
	100142	Schwingungsdämpfer <i>vibration damper</i>	40x40x8	
	100130	Gummipuffer <i>vibration damper</i>	75x75x12	
	100903	Steckverbinder M-Teil <i>plug</i>		
	100904	Steckverbinder V-Teil <i>plug</i>		